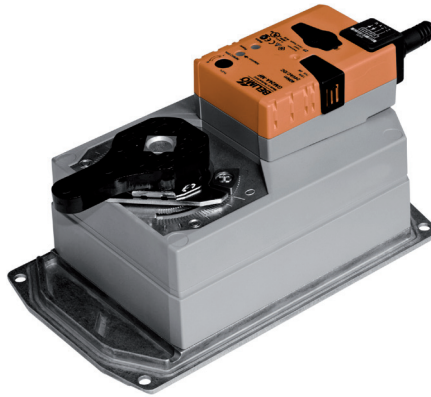

Rotary actuator for butterfly valves

- Nominal torque <90 Nm (not constant)
- Nominal voltage AC/DC 24 V
- Control Open-close
- Running time motor 35 s

Technical data

Electrical data	Nominal voltage	AC/DC 24 V
	Nominal voltage frequency	50/60 Hz
	Nominal voltage range	AC 19.2...28.8 V / DC 19.2...28.8 V
	Power consumption in operation	9 W
	Power consumption in rest position	2 W
	Power consumption for wire sizing	12 VA
	Connection supply / control	Cable 1 m, 3 x 0.75 mm ²
	Parallel operation	No
Functional data	Torque motor	Max. <90 Nm (not constant)
	Manual override	Gear disengagement with push-button, can be locked
	Running time motor	35 s / 90°
	Sound power level motor	45 dB(A)
	Position indication	Mechanically (integrated)
Safety	Protection class IEC/EN	III Safety extra-low voltage
	Protection class UL	UL Class 2 Supply
	Degree of protection IEC/EN	IP54
	Degree of protection NEMA/UL	NEMA 2, UL Enclosure Type 2
	EMC	CE according to 2004/108/EC
	Certification IEC/EN	IEC/EN 60730-1 and IEC/EN 60730-2-14
	Certification UL	cULus according to UL 60730-1A, UL 60730-2-14 and CAN/CSA E60730-1:02
	Mode of operation	Type 1
	Rated impulse voltage supply / control	0.8 kV
	Control pollution degree	3
Mechanical data	Ambient temperature	-30...50 °C
	Non-operating temperature	-40...80 °C
	Ambient humidity	95% r.h., non-condensing
	Maintenance	Maintenance-free
	Connection flange	F07
Weight	Weight approx.	4.1 kg

Safety notes



- This device has been designed for use in stationary heating, ventilation and air conditioning systems and must not be used outside the specified field of application, especially in aircraft or in any other airborne means of transport.
- Only authorised specialists may carry out installation. All applicable legal or institutional installation regulations must be complied during installation.
- The switch for changing the direction of rotation may not be adjusted.
- The angle of rotation is not permitted to be subjected to mechanical limitation. It is forbidden to alter the mechanical end stops.
- The device may only be opened at the manufacturer's site. It does not contain any parts that can be replaced or repaired by the user.
- Cables must not be removed from the device.

Safety notes

- The device contains electrical and electronic components and must not be disposed of as household refuse. All locally valid regulations and requirements must be observed.
- Because of its non-constant torque, the actuator is neither suitable nor released for motorisation with valves from other manufacturers. No legal entitlement can be claimed, even after extensive testing. Belimo will not be held liable and will provide no warranty.

Product features

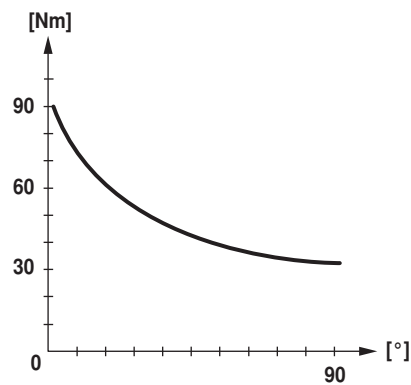
Simple direct mounting	Simple direct mounting on the butterfly valve. The mounting orientation in relation to the butterfly valve can be selected in 90° (angle) increments.
Manual override	Manual override with push-button possible (the gear is disengaged for as long as the button is pressed or remains locked).
High functional reliability	The actuator is overload protected, requires no limit switches and automatically stops when the end stop is reached.
Combination valve/actuator	For valves with the following mechanical specifications in accordance with ISO 5211 F07: - Square stem head SW = 17 mm for form-fit coupling of the rotary actuator. - Hole circle d = 70 mm
Torque not constant	Due to the non linear torque characteristic the actuator can only be used for butterfly valves and not for other armatures.



Accessories

	Description	Type
Electrical accessories	Auxiliary switch, add-on, 1 x SPDT	S1A
	Auxiliary switch, add-on, 2 x SPDT	S2A
	Feedback potentiometer 140 Ohm, add-on	P140A
	Feedback potentiometer 200 Ohm, add-on	P200A
	Feedback potentiometer 500 Ohm, add-on	P500A
	Feedback potentiometer 1 kOhm, add-on	P1000A
	Feedback potentiometer 2.8 kOhm, add-on	P2800A
	Feedback potentiometer 5 kOhm, add-on	P5000A
	Feedback potentiometer 10 kOhm, add-on	P10000A

Electrical installation



Notes

- Connection via safety isolating transformer.

Wiring diagrams

AC/DC 24 V, open-close

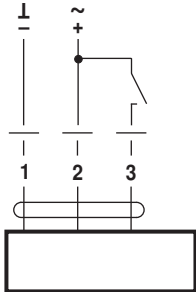

Cable colours:

- 1 = black
- 2 = red
- 3 = white

Dimensions [mm]

Dimensional drawings

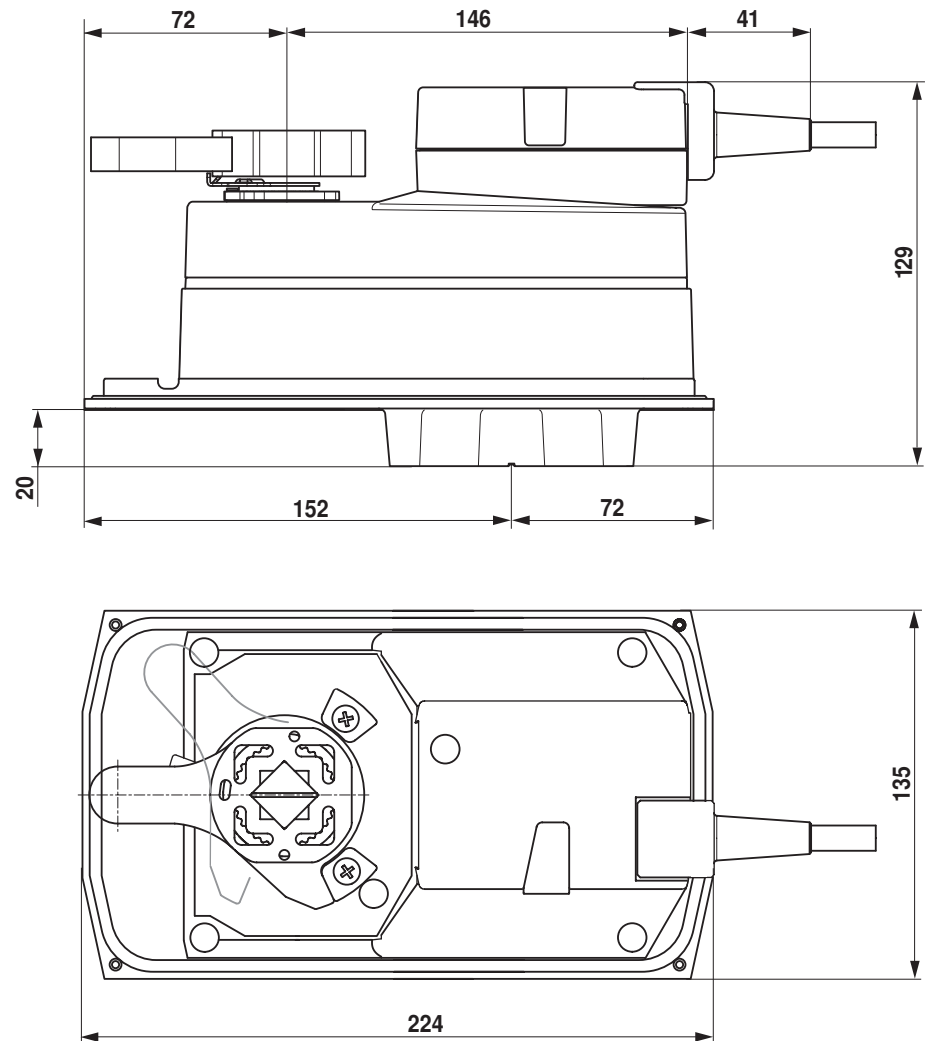

Further documentation

- Overview Valve-actuator combinations
- Data sheets for butterfly valves
- Installation instructions for actuators and/or butterfly valves
- General notes for project planning