



RCF-230AD

Room controller for fan-coil applications with two analogue 0...10 V DC outputs

Intended to control heating and/or cooling in 2- or 4-pipe installations. Setpoint and fan speed are set using the buttons on the front.

RCF-230AD is a controller for controlling heating and/or cooling in a room. It is intended for control of actuators with 0...10 V DC analogue control signal, and also has a function for three-speed fan control (for fan-coil).

The controller uses 230 V AC supply voltage. It has built-in 230 V AC fan relays, which means that a separate relay module is not required for the fan and actuators.

Applications

The controller is suitable in buildings where you want optimal comfort and reduced energy consumption, for example offices, schools, shopping centres, airports, hotels, hospitals etc.

Easy to install

The modular design with a separate bottom plate for wiring makes the controller easy to install and commission. The bottom plate can be put into place before the electronics are installed. Mounting takes place directly on a wall or wall socket.

Control function

The controller controls heating and/or cooling in a room. Control parameters like P-band and I-time can be set in the parameter list via the display. The setpoint can be changed using the INCREASE (▲) and DECREASE (▼) buttons on the front.

See also the section "Display information and handling" on page 3.

Short facts about RCF-230AD

- Supply voltage 230 V AC
- Built-in relays for a 3-speed fan, 230 V AC
- Inputs for presence detector and/or window contact
- Input for automatic change-over cooling/heating
- Min- max supply air temperature limitation

Built-in or external sensor

The controller has a built-in sensor. Alternatively, the input for an external PT1000-sensor can be used.

Output function for actuators with 0...10 V control

The controller has 0...10 V DC outputs. Since it is powered by 230 V AC, the analogue signal neutral on the controller must, in addition to the control signal's plus signal, be connected to the actuator in order for the control signal voltage to be transferred.

The output signal for the two outputs can be set individually to 0...10 V, 2...10 V, 10...0 V and 10...2 V. The factory setting is 0...10 V for both outputs.

2- and 4-pipe installations

In 2-pipe installations, the same water system is used for heating as for cooling. Chilled water circulates through the system during summer and heated water during winter.

When RCF-230AD is configured for a 2-pipe system, output AO1 is used for controlling heating or cooling (depending on the season (fluid temperature)) via an actuator, a valve or similar (change-over function).

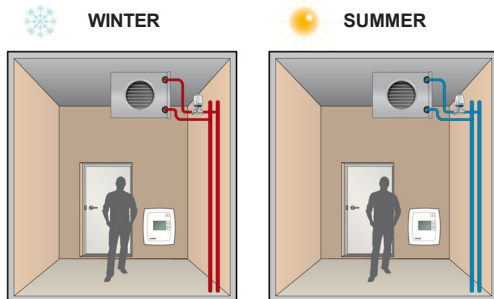

In 4-pipe installations, there are two separate water systems for heating and cooling with separate valves. The controller uses two outputs for control of heating and cooling in sequence.

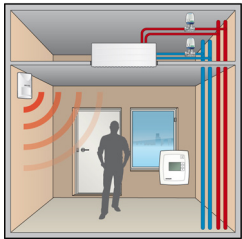

Automatic cooling/heating change-over

RCF-230AD has an input for change-over which is used when the controller is configured for 2-pipe installations. It sets output AO1 to operate with heating or cooling function depending on the fluid temperature (season).

The change-over input can be connected to a potential-free relay contact or a PT1000-sensor.

The input function for the relay contact can be set to normally open (NO) or normally closed (NC). If the change-over input is not used, we recommend that it is left disconnected and set to NO (factory setting).

When using a sensor, it must be mounted so that it can measure the temperature on the supply pipe to the coil. To ensure satisfactory function, the system must also have continuous primary circuit circulation. Using a sensor, the output function is set to heating when the fluid temperature exceeds 28°C and to cooling when the temperature falls below 16°C.

At heating function "HEAT" is shown in the display and at cooling function "COOL" is shown.

Occupancy detection for saving energy

By connecting an occupancy detector or a keycard switch (in hotels) to a digital input, you can alternate between Comfort and Economy mode. This way, the temperature is controlled from requirement, making it possible to save energy while maintaining the temperature at a comfortable level.

Using occupancy detection, you can delay activation and/or inactivation of Comfort mode to avoid switching mode if someone temporarily enters or leaves the room.

A window contact can be connected to either digital input 1 or universal input 1. The window contact will set the controller to "Off" mode if a window is opened, thereby minimising energy consumption.

Operating modes

There are four different operating modes, Comfort, Economy (Standby), Off and Window. Switch-over between these modes is performed locally.

Comfort:  is shown in the display and the room is in use. The temperature is held at the comfort level with a deadband (DB) between activation of heating and cooling.

Economy (Standby): "Standby" is shown in the display. The room is in an energy saving mode and is not used at the moment. This can for example be during nights, weekends, evenings etc. or during daytime when there is no one in the room. The controller is prepared to change operating mode to Comfort if someone enters the room. Heating and cooling have freely adjustable setpoints.

Off: "Off" is shown in the display and the backlight is switched off. The controller neither heats or cools and the fan stops (except if mould protection has been selected, in which case the fan will keep running). Off mode is selected by pressing the On/Off button.

Window:  is shown in the display and the controller is in off mode and the fan stops (except if mould protection has been selected, in which case the fan will keep running).

Fan speed control

The current fan speed is shown in the display and can be set manually to Low → Medium → High → Auto by pressing the fan button. In Auto mode, fan speed is controlled by the controller output.

When there is no heating or cooling demand in the Auto position, the fan will run at its lowest setting. This function can be changed to make the fan stop when there is no heating or cooling demand. The fan is also deactivated when in modes Off and Window. However, it will continue to run if mould protection has been configured.

If the fan has been configured to not be affected by controller output, the "AUTO" option will not be shown when pressing the fan button.

Mould protection

When this function has been configured, the fan will run at a minimum of the lowest speed setting, circulating air in the room so as to minimise the risk of mould growth in the fan-coil unit. The function is deactivated on delivery.

Automatic valve exercise

To ensure proper functionality, the controller has a function for valve exercise, even during periods when they are not in use. At regular intervals the output is overridden to close for a moment in order to open and close the valves. The exercise interval can be set individually for heating and cooling. The exercise function can also be inactivated if desired.

Display information and handling

The display has the following indications:

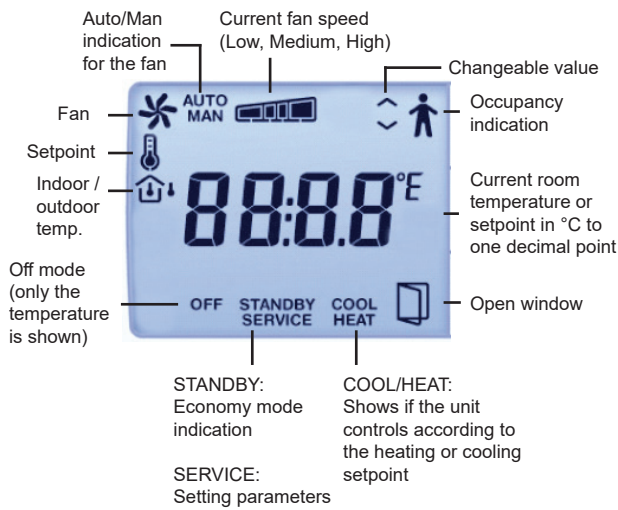

The display is handled using the buttons on the controller:

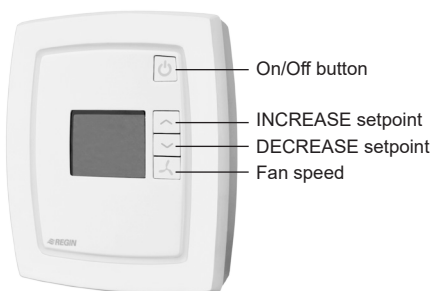

On/Off button

By pressing the On/Off button, RCF-230AD will switch between Off mode and Comfort/Economy mode.

Setpoint buttons

The INCREASE and DECREASE buttons are used to change the setpoint value. The basic setpoint can be changed within adjustable min./max. limits.

Fan button

By pressing the fan button, the fan speed is set to Low, Medium, High or Auto.

Blocking

The buttons of the controller, the configuration menu and the manual fan control can all be blocked in order to prevent settings from being changed by unauthorized individuals.

Configuration

The factory settings are changed in the parameter list shown in the display by using the buttons on the controller.

The parameter values are changed with the INCREASE and DECREASE buttons and changes confirmed with the On/Off button.

The parameter list can be found in the instruction for RCF-230AD and in the manual for RCF.

Display configuration

The desired contents of the display can be configured via the parameter list. There are four alternatives:

1. The actual value is normally shown. The setpoint is shown when it is changed using the INCREASE and DECREASE buttons.
2. The actual value is normally shown. The setpoint displacement is shown when it is changed using the INCREASE and DECREASE buttons.
3. The setpoint value is shown (factory setting).
4. The setpoint adjustment is shown.

Control principles

Control principle at cooling function, 2-pipe installations

During control of cooling, the output starts to increase when the temperature has exceeded the setpoint value.

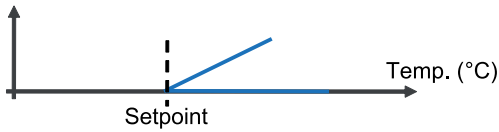

Control principle for heating function, 2-pipe installations

During control of heating, the output starts to increase when the temperature has fallen below the setpoint value.

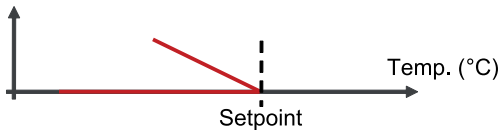

Control principle in 4-pipe installations

In order to minimise energy consumption at Comfort mode, neither heating nor cooling is used when the temperature lies within the deadband. The heating output is activated when the temperature has fallen below the set value for the deadband. The cooling output is activated when the temperature has exceeded the set value for the deadband. The deadband is divided into two equal parts with one part below and one part above the setpoint. See the figure below.

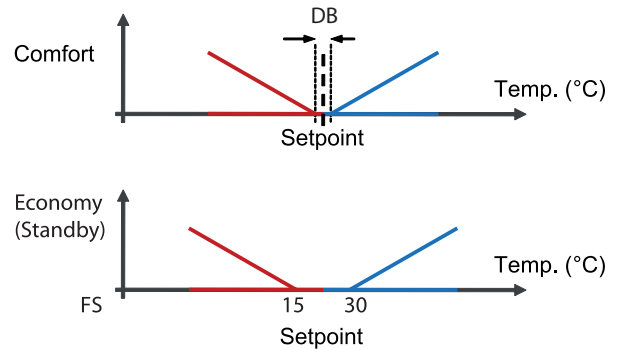

The above figure of the control principle show the corresponding requirement of the controller function. This requirement is recalculated by the controller to a value for the actuator output, depending on the selected output function.

Supply air temperature limitation

All can be configured for use with a supply air temperature limitation sensor. A room controller will then work together with a supply air temperature controller using cascade control, resulting in a calculated supply air temperature maintaining the room temperature setpoint. It is possible to set individual min/max limitation setpoints for heating and cooling. Settable temperature range: 10...50°C.

Technical data

Supply voltage	230 V AC \pm 10 %, 50/60 Hz
Power consumption	3 W, class II construction
Ambient temperature	0...50°C
Storage temperature	-20...+70°C
Ambient humidity	Max. 90 % RH
Protection class	IP20
Pollution degree	2
Overvoltage category	3
Display	LCD with backlight
Build-in temperature sensor	NTC type, range 0...50°C,
Terminals	Lift type for maximum cable area. 2.1 mm ²
Material, casing	Polycarbonate, PC
Colour	
Cover	Polar white RAL9010
Bottom plate	Light grey
Mounting	Indoor, wall mounting, fits on a standard wall socket
Dimensions (HxWxD)	120 x 102 x 29 mm
Weight	0.18 kg

**Low Voltage Directive (LVD) standards / EMC emissions & immunity standards:**

This product conforms to the EMC and LVD requirements in the European harmonised standards EN 60730-1:2000 and EN 60730-2-9:2002. It carries the CE mark.

RoHS: This product conforms to the Directive 2011/65/EU of the European Parliament and of the Council.

Inputs

External sensor, AI1	PT1000-sensor. Suitable sensors are TG-R5/PT1000, TG-UH/PT1000, TG-A1/PT1000 and TG-K3-PT1000 from Regin.
UI1	Change-over, potential-free contact or PT1000-sensor. Suitable sensor is TG-A1/PT1000 from Regin or window contact.
Occupancy/window contact, DII	Potential-free contact. A suitable occupancy detector is IR24-P from Regin.

Outputs

Fan control, DO1, 2, 3	3 outputs for speed I, II and III, 230 V AC, max. 3 A fan-coil
Valve, DO4, DO5	2 outputs, 230 V AC, max. 300 mA (3 A initially)
Output AO1, AO2	0...10 V DC, max. 1 mA, short-circuit proof, reversable to 2...10 V, 10...0 V, 10...2 V

Settings

	Possible settings	Factory setting (FS)
Basic setpoint	5...50°C (0...100°C with Regio tool®)	22°C
Internal sensor calibration	-10...10 K	0 K
External sensor calibration	-10...10 K	0 K
P band	1...300°C	10°C
I-time	0...1000 s	300 s
DB, deadband at Comfort	0.1...10 K	2 K
Installation type	2- or 4-pipe	2-pipe
Input DII	Normally open (NO) or normally closed (NC)	NO
Input UII	NO or NC, when used as a relay contact input	NO
Valve exercise	Individually settable for heating and cooling outputs	23 hours interval

Wiring

10	L	230 V AC L	Supply voltage
11	-	Not connected	
12	N	230 V AC N	Supply voltage (internally connected to terminal 13)
13	N	Fan-coil common / 230 V AC N	Common fan-coil connector (internally connected to terminal 12)
20	DO1	Fan-coil output 1 for fan control	Relay, 230 V AC*, 3 A
21	DO2	Fan-coil output 2 for fan control	Relay, 230 V AC*, 3 A
22	DO3	Fan-coil output 3 for fan control	Relay, 230 V AC*, 3 A
30-33	-	Not connected	
40	DI	Digital input	Floating (potential-free) window contact or occupancy contact. Configurable for NO/NC.
41	Agnd	Analogue ground	
42	AI	Analogue input	PT1000, external room sensor or supply sensor
43	UI	Universal input	Change-over input, floating (potential-free) switch (configurable for NO/NC) or PT1000, alternatively a window contact.
44	Agnd	Analogue ground	
50	Agnd	Analogue ground	
51	AO1	Analogue output 1	
52	AO2	Analogue output 2	
53-54	-	Reserved for future use	

*The sum of the current through DO1-DO3 is protected by a fuse

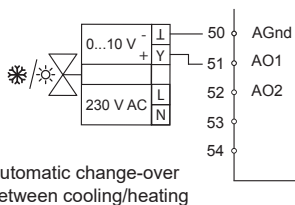
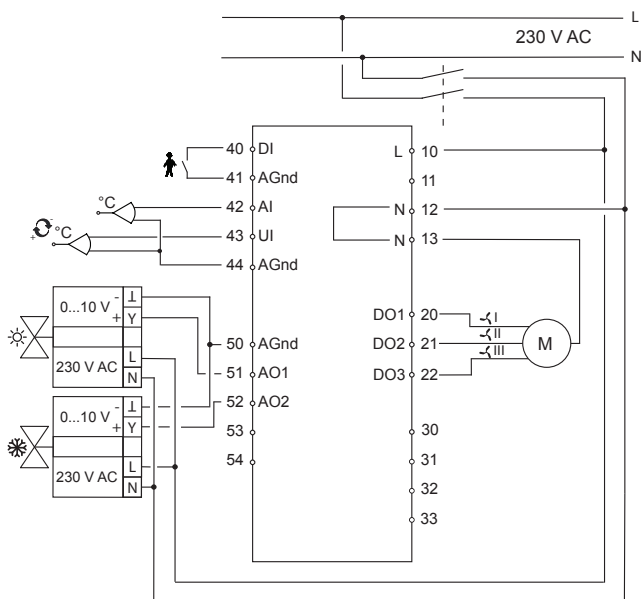

Dimensions

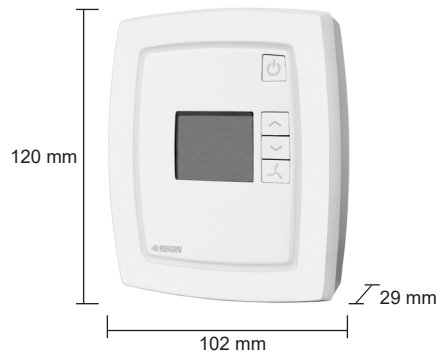

Product documentation

Document	Type
Instruction RCF-230AD	Instruction for RCF-230AD
Manual RCF	Manual for the RCF range

The documents can be downloaded from www.regincontrols.com.